

TRILOK GROUP OF COMPANY

Trilok Infratech

"Smart Concrete"



Mfg. of U Shape Drain, Big Drain (FT Flume), Cable Trench, Box Culvert, Manhole, Precast Compound Wall and Customized Smart Precast Products.

www.trilokinfratech.com



About Trilok Infratech

We Trilok Precast group are leading manufacturer of RCC Precast Prestress Compound Wall And other Precast Products at large scale since 2005 in Surat and 18 state with 47 Cities in India and 2 Plants are Out of india, Senegal and Ecuador Since 4 years

We produce precast products such as U Shape Drain, Box Culvert, Cable Trench, Manhole, Gutter, Precast Prestress Column, Panels, Compound Wall, and Customize Smart Precast Products etc. With New Technology for your customized size using High Performance Concrete grade M - 50 with greatest care to get the maintenance free end product for a long life.

Our Vision

Trilok Precast Group will have 50 plants worldwide with Concept of 21st Century and ISO 9001 : 2015 Co. By 2025. Triok Precast Pvt Ltd. will be at No. 1 position in Precast Industry all over India.

Our Mission

Trilok Infratech is committed to providing high quality smart concrete products and services in an environmental friendly manner, achieving the zenith level in the precast product industry, meeting the needs of customers and employees whilst adding value to the community.



INDEX

U Shape Drain (Heavy)

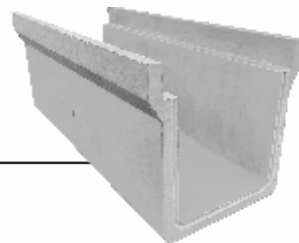

U Shape Drain (Light)

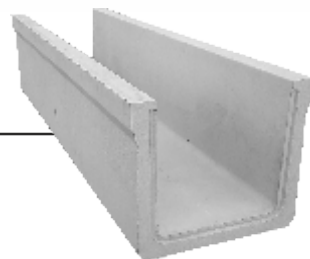

Big Drain (FT Flume)



U Shape Drain (Heavy)

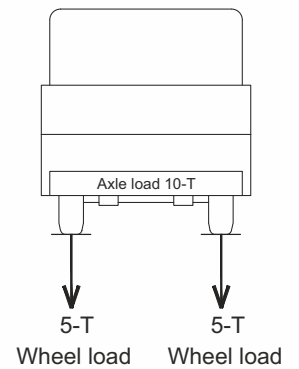
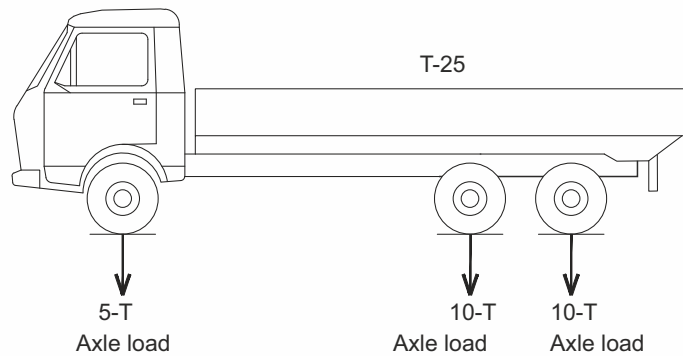
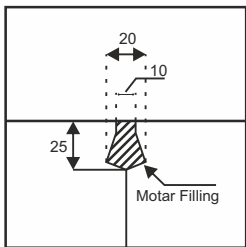

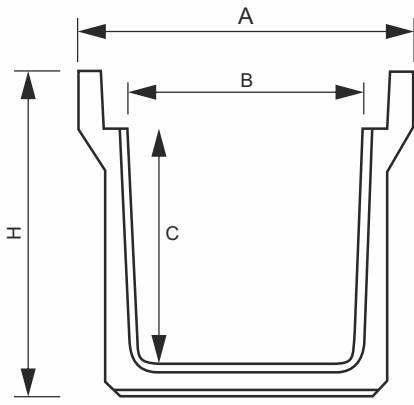

SECTION

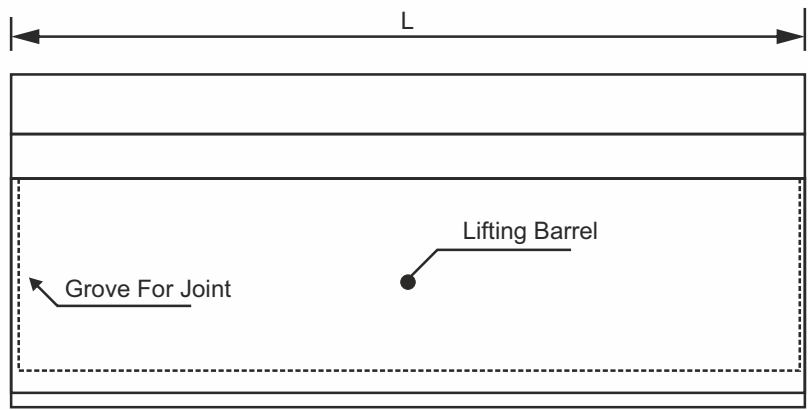

Side View

Size (mm) B x C	Dimensions of U Shape Drain (mm)			
	L	A	B	H
300 x 300	2000	540	300	480
450 x 450	2000	700	450	660
600 x 600	2000	860	600	835
750 x 750	2000	1050	750	990
900 x 900	2000	1200	900	1170

Note: We also make customized size as your requirement.

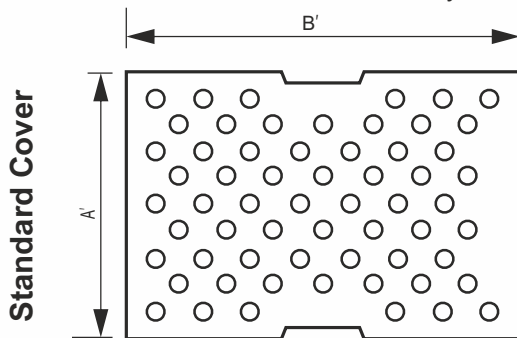

Cover Plan

Drain Size (mm)	Dimensions of Cover (mm)		
	A'	B'	H
300 x 300	500	410	110
450 x 450	500	565	130
600 x 600	500	710	140
750 x 750	500	890	145
900 x 900	500	1050	150

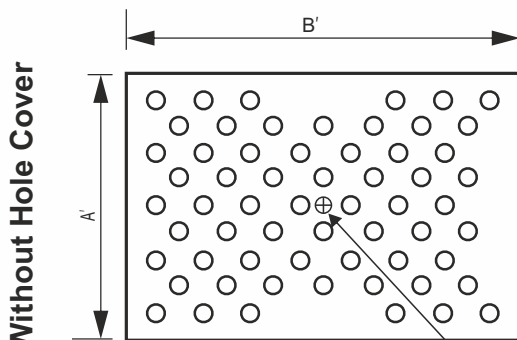

Cover Plan

Lifting Barrel

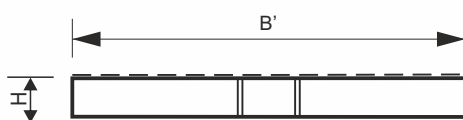

**Cover Side View
Cover Hole**

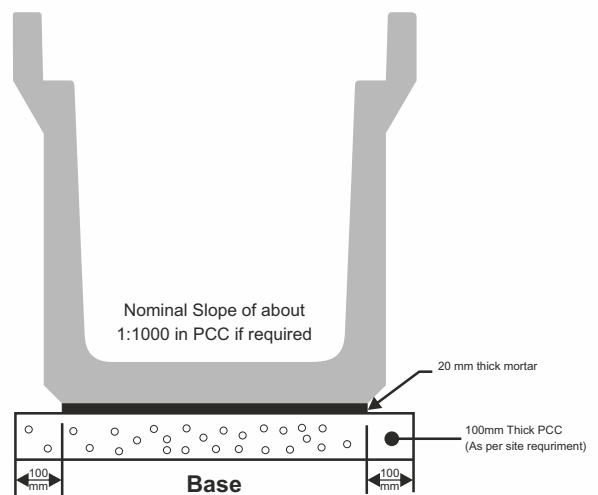

Nominal Slope of about 1:1000 in PCC if required

20 mm thick mortar

100mm Thick PCC (As per site requirement)

Base

U Shape Drain (Light)

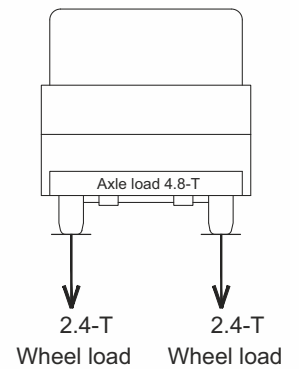
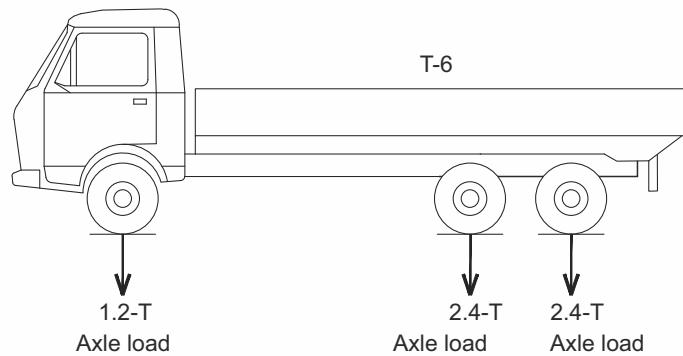
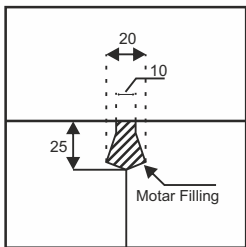

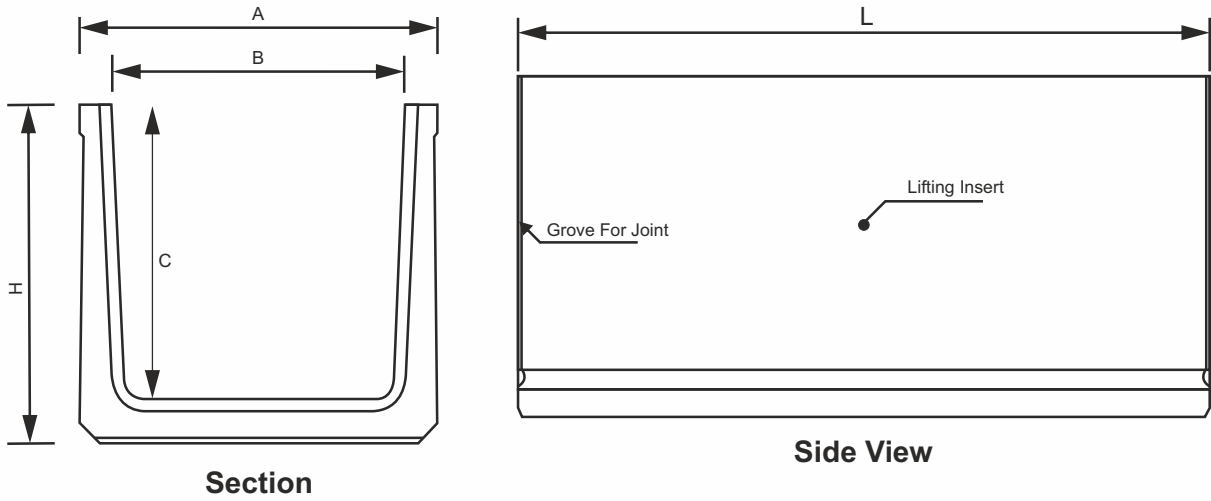

Size (mm) B x C	Dimensions of U Shape Drain (mm)			
	L	A	B	H
300 x 300	2000	440	300	370
450 x 450	2000	610	450	525
600 x 600	2000	720	600	680
750 x 750	2000	890	750	840
900 x 900	2000	1060	900	1010

Note: We also make customized size as your requirement.

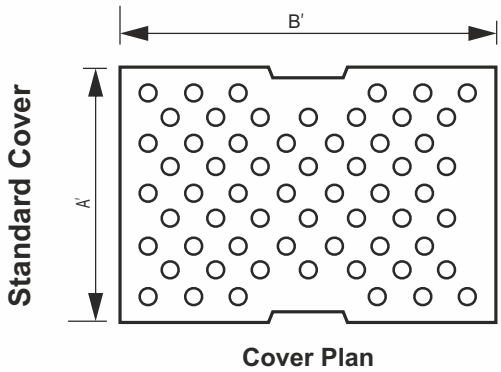

Drain Size (mm)	Dimensions of Cover (mm)		
	A'	B'	H
300 x 300	500	440	60
450 x 450	500	610	80
600 x 600	500	720	80
750 x 750	500	890	90
900 x 900	500	1060	100

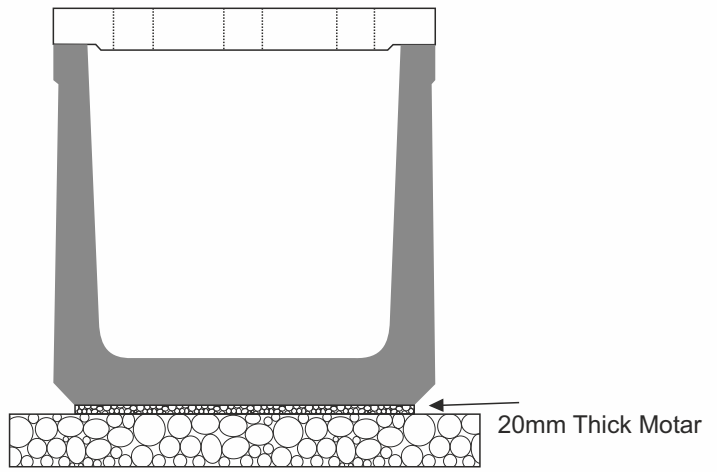
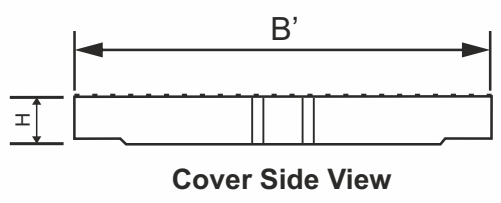
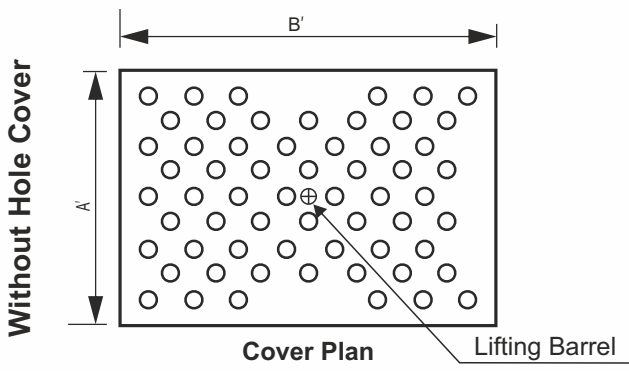

Big Drain (FT Flume)

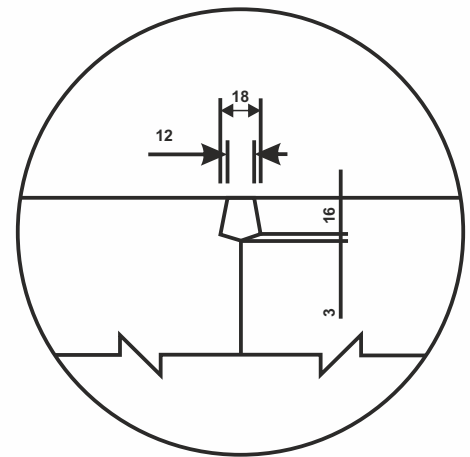
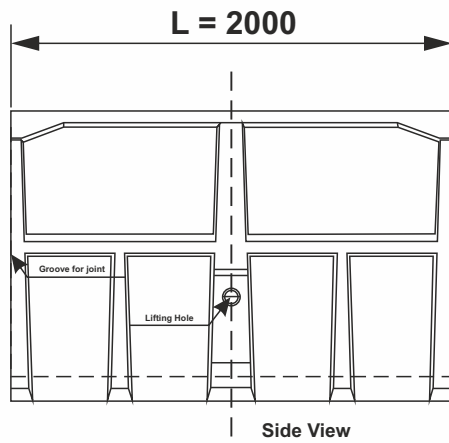
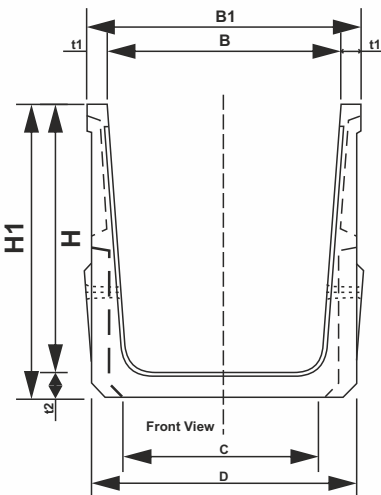
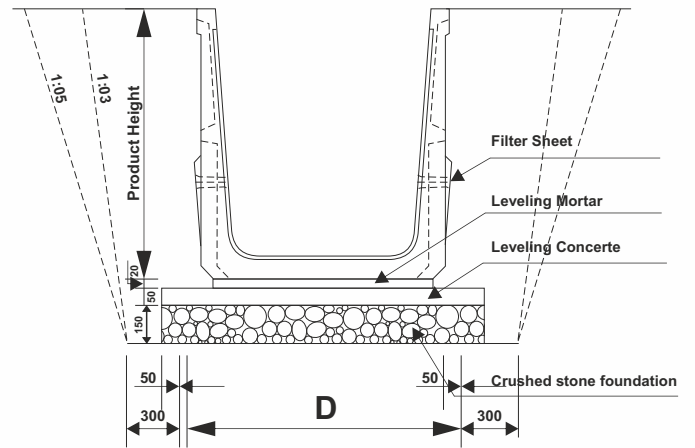

Typical Groove for Joint

H : 900 (H1 : 995)

(All dimensions are in mm)

Width : B	600	700	800	900	1000	1100	1200	1300	1400	1500	1600	1700	1800
B1	780	880	980	1080	1180	1280	1380	1480	1580	1680	1780	1880	1980
C	465	565	665	765	865	965	1065	1165	1265	1365	1465	1565	1665
D	740	840	940	1040	1140	1240	1340	1440	1540	1640	1740	1840	1940

H : 1000 (H1 : 1150)

Width : B	600	700	800	900	1000	1100	1200	1300	1400	1500	1600	1700	1800
B1	780	880	980	1080	1108	1280	1380	1480	1580	1680	1780	1880	1980
C	450	550	650	750	850	950	1050	1150	1250	1350	1450	1550	1650
D	740	840	940	1040	1140	1240	1340	1440	1540	1640	1740	1840	2140

H : 1200 (H1 : 1310)

Width : B	800	900	1000	1100	1200	1300	1400	1500	1600	1700	1800	1900	2000
B1	980	1080	1180	1280	1308	1480	1580	1680	1780	1880	1980	2080	2180
C	620	720	820	920	1020	1120	1220	1320	1420	1520	1620	1720	1820
D	940	1040	1140	1240	1340	1440	1540	1640	1740	1840	1940	2040	2140

H : 1300 (H1 : 1420)

Width : B	800	900	1000	1100	1200	1300	1400	1500	1600	1700	1800	1900	2000
B1	1000	1100	1200	1300	1400	1500	1600	1700	1800	1800	2000	2100	2200
C	605	705	805	905	1005	1105	1205	1305	1405	1505	1605	1705	1805
D	960	1060	1160	1260	1360	1460	1560	1660	1760	1860	1960	2060	2160

H : 1400 (H1 : 1530)

Width : B	800	900	1000	1100	1200	1300	1400	1500	1600	1700	1800	1900	2000
B1	1000	1100	1200	1300	1400	1500	1600	1700	1800	1900	2000	2100	2200
C	590	690	790	890	950	1090	1190	1290	1390	1490	1590	1690	1790
D	960	1060	1160	1260	1360	1460	1560	1660	1760	1860	1960	2060	2160

H : 1500 (H1 : 1640)

Width : B	800	900	1000	1100	1200	1300	1400	1500	1600	1700	1800	1900	2000
B1	1000	1100	1200	1300	1400	1500	1600	1700	1800	1900	2000	2100	2200
C	575	675	775	875	975	1075	1175	1275	1375	1475	1575	1675	1775
D	960	1060	1160	1260	1360	1460	1560	1660	1760	1860	1960	2060	2160

H : 1600 (H1 : 1740)

Width : B	800	900	1000	1100	1200	1300	1400	1500	1600	1700	1800	1900	2000
B1	1000	1100	1200	1300	1400	1500	1600	1700	1800	1800	2000	2100	2200
C	960	1060	1160	1260	1360	1460	1560	1660	1760	1860	1960	2060	2160
D	960	1060	1160	1260	1360	1460	1560	1660	1760	1860	1960	2060	2160

H : 1800 (H1 : 1940)

Width : B	800	900	1000	1100	1200	1300	1400	1500	1600	1700	1800	1900	2000
B1	1070	1170	1270	1370	1470	1570	1670	1770	1870	1970	2070	2170	2270
C	530	630	730	830	930	1030	1130	1230	1330	1430	1530	1630	1730
D	990	1090	1190	1290	1390	1490	1590	1690	1790	1890	1990	2090	2190



Advantages Of U Shape Drain



Made in India
by continue
onward
technology



Best quality
items created
with HPC
M - 40



Production by
talented indian
technial group

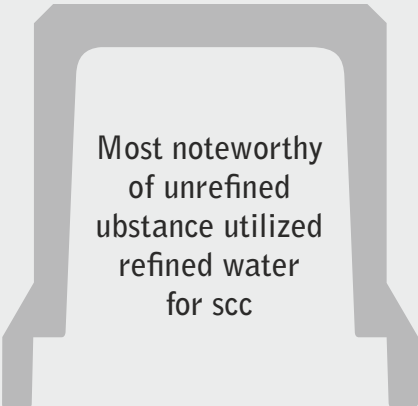

Most noteworthy
of unrefined
ubstance utilized
refined water
for scc



Proper uncovered
substantial
product



Designed as per
the indian
standards

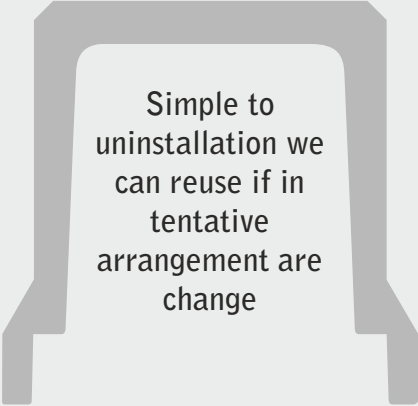

Simple to
uninstallation we
can reuse if in
tentative
arrangement are
change

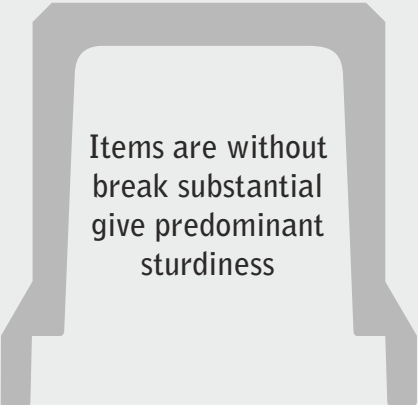

Items are without
break substantial
give predominant
sturdiness



Predominant
quality items
making by forge
ahead innovation



Get the upkeep
free finished
result for
long life

TRILOK INFRATECH

Office Address :

401, Vikas Shopper, Vraj Chowk Road, Opp.
Rushikesh Residency, Sarthana Jakatnaka,
Varachha Road, Surat - 395006 (Gujarat)

Phone : 098795 57125 / 099794 57120

Email : info@trilokinfratech.com

Web : www.trilokinfratech.com
www.trilokwall.com



Please Scan the QR code
to visit our website for
more details.

Represented By :